

HF94

PRO HF HORN



FEATURES

- 1-inch/1.4 inch Throat Adaptor
- 90° x 40° Constant Directivity Coverage
- Loading down to 500 Hz
- Thick Aluminum Body for best heat dissipation in conjunction to Neodimium Compression Drivers
- Perfectly Controlled Dispersion

TECHNICAL SPECIFICATIONS

General specifications	Throat Diameter:	25-36 mm / 1.0-1.4 inch
	Horizontal coverage angle:	90°
	Vertical coverage angle:	40°
	Cut-off Frequency:	500 Hz
	Material:	Aluminium
Mounting informations	Overall height:	250 mm / 9.84 inches
	Overall width:	250 mm / 9.84 inches
	Overall depth:	135 mm / 5.31 inches
	Baffle Cut-out height:	205 mm / 8.07 inches
	Baffle Cut-out width:	205 mm / 8.07 inches
	Mounting:	4 x 7 mm holes, interaxes 101 mm/76 mm
Standard compliance	CE marking:	Yes
Physical specifications	Color:	Black
Size	Height:	142 mm / 5.59 inches
	Diameter:	250 mm / 9.84 inches
	Weight:	1.12 kg / 2.47 lbs
Shipping informations	Package Height:	155 mm / 6.1 inches
	Package Width:	265 mm / 10.43 inches
	Package Depth:	265 mm / 10.43 inches
	Package Weight:	2 kg / 4.41 lbs

PART NUMBER

- **13133047**

HF94

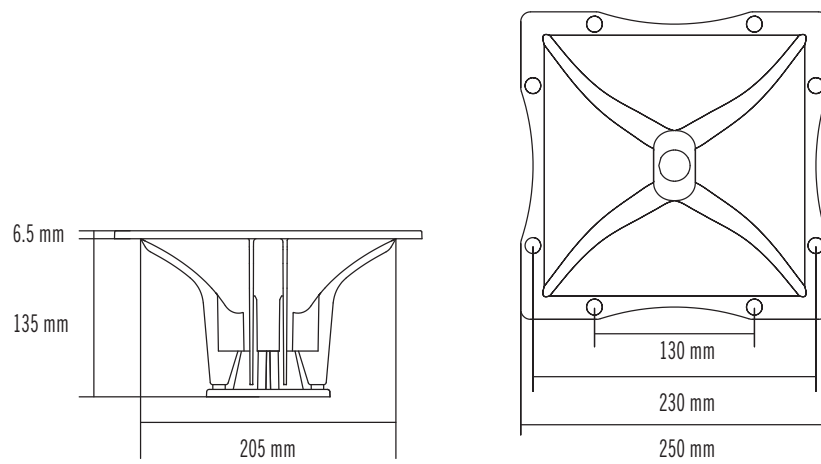

Response 1W/1m

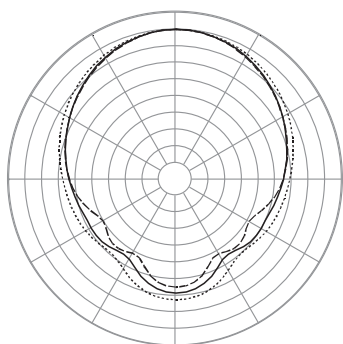
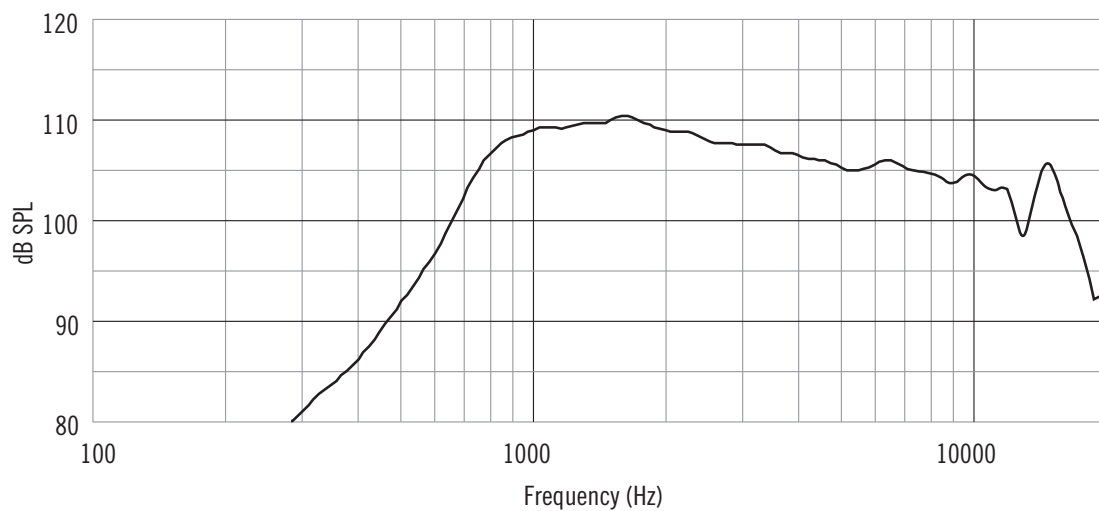

Horizontal 2000 Hz
1/3 Octave Polars

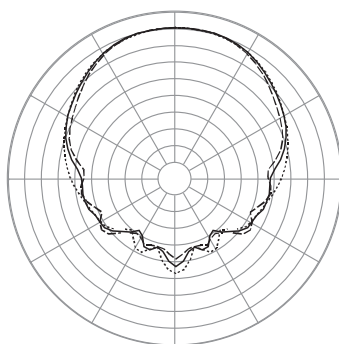

Horizontal 4000 Hz
1/3 Octave Polars

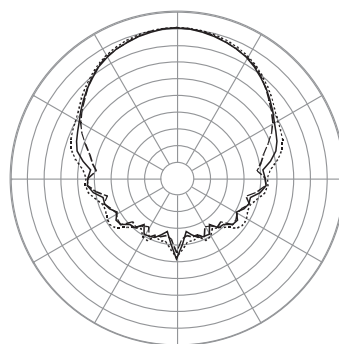

Horizontal 8000 Hz
1/3 Octave Polars

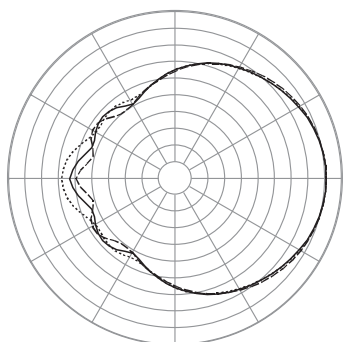

Vertical 2000 Hz
1/3 Octave Polars

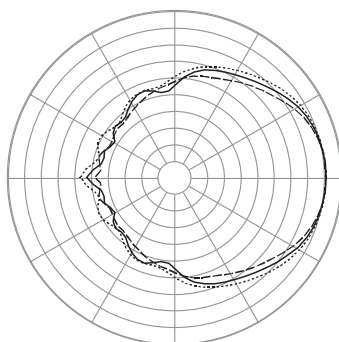

Vertical 4000 Hz
1/3 Octave Polars

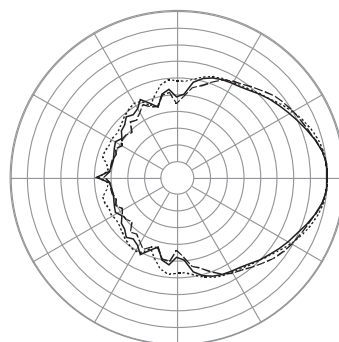

Vertical 8000 Hz
1/3 Octave Polars